



INSTRUCTION MANUAL

VHF P25 TRUNKING
MOBILE TRANSCEIVER

IC-F9511HT



This device complies with Part 15 of the FCC Rules. Operation is subject to the condition that this device does not cause harmful interference.

Icom Inc.

IMPORTANT

READ ALL INSTRUCTIONS carefully and completely before using the transceiver.

SAVE THIS INSTRUCTION MANUAL — This instruction manual contains important operating instructions for the **IC-F9511HT VHF MOBILE TRANSCEIVER**.

✓ **When the optional UT-125 AES/DES ENCRYPTION UNIT is installed:**

When you attempt to re-export this product and/or AES encryption of this product is activated, you must comply with the export regulations of your country, which can be highly restrictive. **YOUR FAILURE TO COMPLY WITH EXPORT REGULATIONS MAY SUBJECT YOU TO FINES OR PENALTIES.** AES encryption products including this software fall under the control of the Japanese Government as described in Appendix I: Export Legal Controls and Appendix: Exchange Legal Controls. Please consult with your dealer or sales representative for details.

Icom, Icom Inc. and the Icom logo are registered trademarks of Icom Incorporated (Japan) in Japan, the United States, the United Kingdom, Germany, France, Spain, Russia and/or other countries.

All other products or brands are registered trademarks or trademarks of their respective holders.

EXPLICIT DEFINITIONS

WORD	DEFINITION
 WARNING!	Personal injury, fire hazard or electric shock may occur.
CAUTION	Equipment damage may occur.
NOTE	If disregarded, inconvenience only. No risk of personal injury, fire or electric shock.

 See the operating guide for details of Analog, MDC and APCO P25 system operations. Consult your Icom dealer or system operator for details concerning your transceivers programming.

FCC INFORMATION

• FOR CLASS B UNINTENTIONAL RADIATORS:

This equipment has been tested and found to comply with the limits for a Class B digital device, pursuant to part 15 of the FCC Rules. These limits are designed to provide reasonable protection against harmful interference in a residential installation. This equipment generates, uses and can radiate radio frequency energy and, if not installed and used in accordance with the instructions, may cause harmful interference to radio communications. However, there is no guarantee that interference will not occur in a particular installation. If this equipment does cause harmful interference to radio or television reception, which can be determined by turning the equipment off and on, the user is encouraged to try to correct the interference by one or more of the following measures:

- Reorient or relocate the receiving antenna.
- Increase the separation between the equipment and receiver.
- Connect the equipment into an outlet on a circuit different from that to which the receiver is connected.
- Consult the dealer or an experienced radio/TV technician for help.

ABOUT IPR

This device is made under license under one or more of the following U.S. Patents: #4,590,473; #4,636,791; #5,148,482; #5,185,796; #5,271,017; #5,377,229; #4,716,407; #4,972,460; #5,502,767; #5,146,497; #5,164,986; #5,185,795; #5,164,986; #5,185,795, and #5,146,497.

* IPR means 'Intellectual Property Rights.'

VOICE CODING TECHNOLOGY

The AMBE+2™ voice coding Technology embodied in this product is protected by intellectual property rights including patent rights, copyrights and trade secrets of Digital Voice Systems, Inc. This voice coding Technology is licensed solely for use within this Communications Equipment. The user of this Technology is explicitly prohibited from attempting to extract, remove, decompile, reverse engineer, or disassemble the Object Code, or in any other way convert the Object Code into a human-readable form. U.S. Patent Nos. #5,870,405, #5,826,222, #5,754,974, #5,701,390, #5,715,365, #5,649,050, #5,630,011, #5,581,656, #5,517,511, #5,491,772, #5,247,579, #5,226,084 and #5,195,166.

PRECAUTIONS

⚠ WARNING! NEVER connect the transceiver to an AC outlet. This may pose a fire hazard or result in an electric shock.

⚠ WARNING! NEVER connect the transceiver to a power source of more than 16 V DC or use reverse polarity. This could cause a fire or damage the transceiver.

⚠ WARNING! NEVER cut the DC power cable between the DC plug and fuse holder. If an incorrect connection is made after cutting, the transceiver may be damaged.

CAUTION: NEVER place the transceiver where normal operation of the vehicle may be hindered or where it could cause bodily injury.

CAUTION: NEVER allow children to touch the transceiver.

CAUTION: NEVER expose the transceiver to rain, snow or any liquids. The transceiver may be damaged.

USE the specified microphone only. Other microphones have different pin assignments and may damage the transceiver.

DO NOT use or place the transceiver in areas with temperatures below -30°C (-22°F) or above $+60^{\circ}\text{C}$ ($+140^{\circ}\text{F}$), or in areas subject to direct sunlight, such as the dashboard.

DO NOT place the transceiver in excessively dusty environments.

DO NOT operate the transceiver without running the vehicle's engine. The vehicle's battery will quickly run out if the transceiver transmits while the vehicle's engine OFF.

DO NOT place the transceiver against walls. This will obstruct heat dissipation.

DO NOT use harsh solvents such as benzine or alcohol when cleaning, as they damage the transceiver surfaces.

BE CAREFUL! The transceiver will become hot when operating continuously for long periods.

KEEP the transceiver away from heavy rain, and never immerse it in the water.

When the supplied/optional microphone*, the front/rear plate(s) and the speaker jack cover of the controller are attached, the main unit and the controller meet IP54 requirements for dust-protection and splash resistance.

However, once these items have been dropped, dust-protection and splash resistance cannot be guaranteed because of possible damage to these cases or the waterproof seal.

* The microphone is not dust-protection and splash resistance.

For U.S.A. only

CAUTION: Changes or modifications to this transceiver, not expressly approved by Icom Inc., could void your authority to operate this transceiver under FCC regulations.

TABLE OF CONTENTS

IMPORTANT	i
EXPLICIT DEFINITIONS	i
FCC INFORMATION	ii
ABOUT IPR	ii
VOICE CODING TECHNOLOGY	ii
PRECAUTIONS	iii
TABLE OF CONTENTS	iv
1 PANEL DESCRIPTION.....	1-6
■ Front panel— Controller	1
■ Function display— Controller	3
■ Programmable function keys	4
2 BASIC OPERATION.....	7-13
■ Turning power ON	7
■ Channel selection.....	7
■ Receiving and transmitting	8
■ Clock function.....	9
■ Wake up function	10
■ Sleep function	11
■ User set mode.....	12

3 CONNECTION AND MAINTENANCE	14-21
■ Separation cable connection	14
■ Rear panel connection	16
■ Supplied Accessories	17
■ Mounting the transceiver.....	18
■ Antenna.....	20
■ Fuse installation	20
■ Cleaning.....	20
■ Speaker connector information	21
4 OPTIONS.....	22
5 SAFETY TRAINING INFORMATION.....	23

1

PANEL DESCRIPTION

■ Front panel— Controller

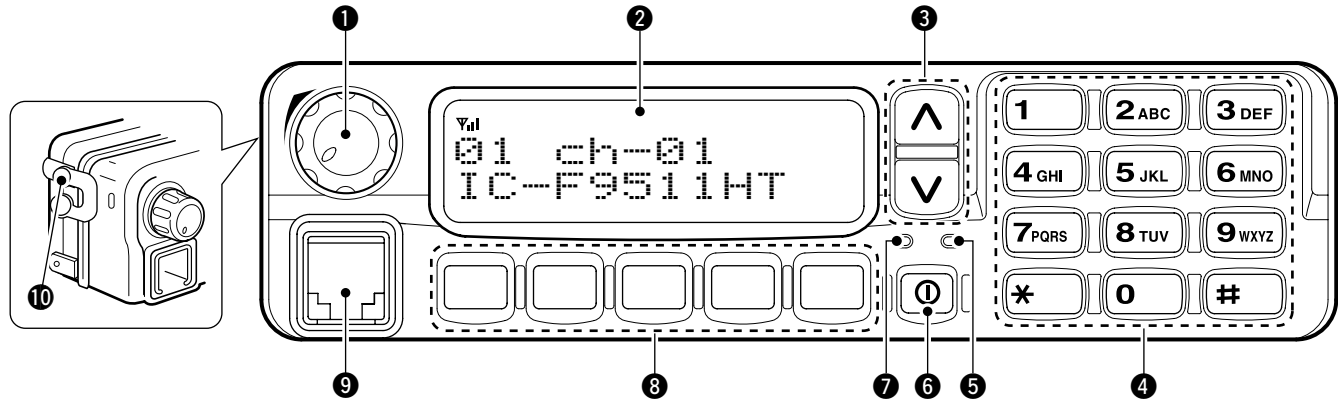

1 AF VOLUME CONTROL KNOB

- Rotate the knob to adjust the audio output level.
- Minimum audio level is pre-programmed.

2 FUNCTION DISPLAY (p. 3)

Displays a variety of information, such as an operating channel number/name, DTMF numbers and audible condition, etc.

3 UP/DOWN KEYS

Push to select an operating channel, etc.

*The desired function can be assigned by your dealer. (p. 4)

4 10-KEYPAD

The keypad allows you to enter digits to:

- Select memory channels, tone channels and DTMF codes (when in the DTMF code channel selection mode)
- Start up with a password
- Input the Individual ID code during P25 mode operation. (Depending on the pre-setting)

5 BUSY INDICATOR

Lights green while receiving a signal, or when the squelch is open.

6 POWER SWITCH [POWER]

Push to turn the power ON and OFF.

- The following functions are available at power ON as options:
 - Automatic scan start
 - Password prompt
 - Set mode

7 TRANSMIT INDICATOR

Lights red while transmitting.

8 DEALER-PROGRAMMABLE KEYS

Desired functions can be programmed independently by your dealer. (p. 4)

/// In this instruction manual, these keys are from the left, called [P0]/[P1]/[P2]/[P3]/[P4].

9 MICROPHONE CONNECTOR

Connect the supplied or optional microphone.

- When you connect a microphone, be sure to fit the connector cover of the microphone into the connector to maintain the controller's dust protection and splash resistance.

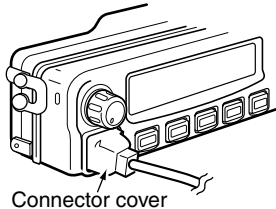

/// **NEVER** connect non-specified microphones. The pin assignments may be different and the transceiver may be damaged.

◇ **MICROPHONE**

The supplied microphone has a PTT switch and a hanger hook.

- The following functions are available when the microphone is on or off hook (depending on the setting):
 - Automatic scan starts when it is on hook.
 - Scan is cancelled when it is off hook.
 - Scan is paused when it is off hook.
 - Automatic priority channel selection is available when it is off hook.
 - Sets to 'Inaudible' condition (mute condition) when it is on hook.
 - Sets to 'Audible' condition (unmute condition) when it is off hook.

⑩ **SPEAKER JACK**

Connect a 4–8 Ω external speaker.

- Max. input power: 7 W
- Attach the jack cover when no external speaker is connected.

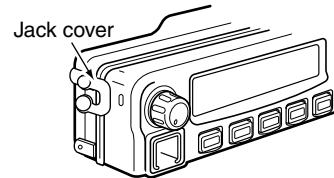

1 PANEL DESCRIPTION

■ Function display— Controller

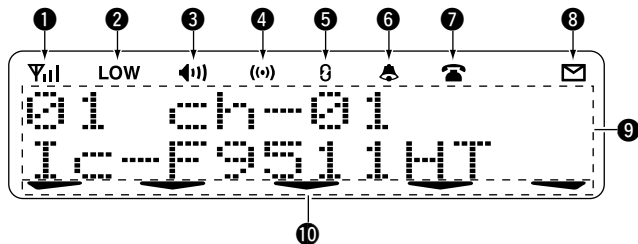

① RECEIVED SIGNAL STRENGTH INDICATOR

Indicates relative signal strength level.



Weak ← Receive Signal level ⇒ Strong

② LOW POWER INDICATOR

Appears when low output power is selected.

- When high output power is selected, no indicator appears.

③ AUDIBLE INDICATOR

Appears when the channel is in the 'Audible' (unmute) condition.

④ COMPANDER INDICATOR

Appears when the compander function* is activated.

* Analog mode operation only

⑤ SCRAMBLER INDICATOR

Appears when the voice scrambler or encryption function is activated.

⑥ BELL INDICATOR

Appears/blinks when a matched signal is received, depending on the pre-programming.

⑦ TELEPHONE INDICATOR

Appears when a phone call* is received.

* P25 operation only

⑧ SHORT MESSAGE INDICATOR

Appears when an Status message or Short message is received.

⑨ ALPHANUMERIC DISPLAY

Displays an operating channel number, channel name, Set mode contents, DTMF code, etc.

⑩ ACTIVATED KEY INDICATOR

Appears above the key assigned as [Scan Add/Del (Tag)] key when that key has been activated.

See the operating guide for details of Analog, MDC and P25 Trunking/Conventional system operations. Consult your Icom dealer or system operator for details concerning your transceiver's programming.

■ Programmable function keys

The following functions can be assigned to [UP], [DOWN], [P0], [P1], [P2], [P3] and [P4] programmable function keys. Consult your Icom dealer or system operator for details concerning your transceivers programming.

If the programmable function names are bracketed in the following explanations, the specific key is used to activate the function depends on the programming.

CH UP AND DOWN KEYS

- Push to select an operating channel.
- Push to select a scan group after pushing and holding [Scan].

ZONE KEY

Push this key, then push [CH Up] or [CH Down] to select the desired zone.

/// **What is “zone”?**—The desired channels are assigned into a zone according to the intended use for grouping. For example, ‘Staff A’ and ‘Staff B’ are assigned into a “Business” zone, and ‘John’ and ‘Cindy’ are assigned into a “Private” zone.

SCAN KEY

- Push to start and cancel scanning operation.
 - When the Power ON Scan or Auto Scan function starts a scan, push this key to cancel the scan. The canceled scan resumes after a specified time period.
- Push and hold this key for 1 sec. to indicate a scan group, then push [CH Up] or [CH Down] to select the desired one. (Depending on the pre-setting.)

SCAN ADD/DEL (TAG) KEY

- Push to add the selected channel to or delete it from the scan group.
 1. Push to indicate a scan group, then push [CH Up] or [CH Down] to select the desired one.
 2. Push to add the channel to or delete it from the selected scan group.
 3. Push and hold for 1 sec. to exit the scan group selection mode.
- While a scan is paused on a non-priority channel, push this key to delete the selected channel from the scan group.
 - Depending on the pre-setting, the deleted channel is added to the scan group again, after the scan is canceled. (Nuisance Delete function)

1 PANEL DESCRIPTION

PRIO A/B KEYS

- ➔ Push to select Priority A or Priority B channel.
- ➔ Push and hold [Prio A (Rewrite)] or [Prio B (Rewrite)] for 1 sec. to assign the operating channel to the Priority A or Priority B channel.

MR-CH 1/2/3/4 KEYS

Push to select the memory channel 1, 2, 3 or 4.

MONI KEY

- ➔ Push to mute and release the CTCSS (DTCS), 2-tone, NAC or Talkgroup ID squelch mute. Open any squelch/de-activate any mute while pushing this key.
 - Depending on the pre-setting, the 'Audible' (unmute) condition may automatically return to the 'Inaudible' (mute) condition, after a specified time period.
- ➔ Depending on the pre-setting, pushing and holding this key for 1 sec. cancels the scan.

TALK AROUND KEY (Conventional operation only)

Turn the talk around function ON or OFF.

- The talk around function equalizes the transmit frequency to the receive frequency for transceiver-to-transceiver communication.

PUBLIC ADDRESS KEY

Push to activate the Public Address (PA) function for voice amplification. When the PA function is activated, the audio output can be controlled from the transceiver separately with [CH Up] or [CH Down].

- This function is available when the external unit, such as an audio amplifier, speaker, etc. is additionally connected. (p. 16)
- Push this key, then speak into the microphone while pushing and holding [PTT].

 **NOTE:** "PA/RX Speaker" setting should be turned OFF by your dealer with the CS-F9010/F9510 CLONING SOFTWARE to activate the PA function. Ask your dealer for details.

RX SPEAKER KEY

Push to turn the RX speaker function ON or OFF.

When the RX speaker function is turned ON, the received audio can be heard via the external speaker.

- This function is available when the external speaker is additionally connected. (p. 16)
- This function is useful when you are out of the vehicle.
- The audio output level is linked to the transceiver's volume control.

 **DO NOT** operate this key with this transceiver. Otherwise no audio may be emitted.

LOCK KEY

Push and hold to electronically lock all programmable keys except the following:

[Moni], [Light], [Lock], [Emergency], [Surveillance] and [OPT 1/2/3].

LIGHT KEY

Push to turn the transceiver's backlight ON for about 5 sec. when the backlight function is turned OFF in user set mode. (p. 12)

HIGH/LOW KEY

Push to select the transmit output power temporarily or permanently, depending on the pre-setting.
• Ask your dealer for the output power level for each selection.

SURVEILLANCE KEY

Push to turn the surveillance function ON or OFF. When this function is turned ON, the beep is not emitted and the LCD backlight does not light when a signal is received or a key is pushed, etc.

HOOK SCAN KEY

When the on hook scan function is activated, push this key to stop scanning temporarily. Push this key again to re-start scanning.

USER SET MODE KEY

- Push and hold to enter user set mode.
 - During in the user set mode, push this key to select an item that is enabled by your dealer, and change the value or condition by pushing [CH Up] or [CH Down].
- Push and hold this key again to exit user set mode.

User set mode is also available via the 'Power ON function.' Refer to p. 12 also.

OPT 1/2/3 KEYS

Push to control the output signal level from the optional unit connector.

CLOCK KEY

- Push to indicate the current time on the LCD. (p. 9)
 - While the current time is indicated, push and hold this key for 1 sec. to enter the time data edit mode. (p. 9)
- Push and hold for 1 sec. to enter the clock set mode. (pp. 10, 11)
 - During in the clock set mode, push this key to select an item, and change the value or condition by pushing [CH Up] or [CH Down].

HOME KEY

Push to return to normal operation.

■ Turning power ON

When you use the transceiver for the first time, or after the transceiver has been left unused for a long time, make sure to check the date and time indication after turning the power ON. If the time and date are not correct, reset them. (p. 9)

- ① Push [ⓘ] to turn the power ON.
- ② If the transceiver is programmed for a start up password, input the digit codes as directed by your dealer.
 - 10-keypad can be used for password input.
 - The keys as below can be used for password input:
The transceiver detects numbers in the same block as identical. Therefore “01234” and “56789” are the same.

KEY	P0	P1	P2	P3	P4
NUMBER	0 5	1 6	2 7	3 8	4 9

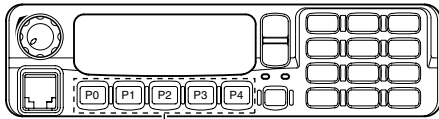

*In this instruction manual, these keys are from the left, called [P0]/[P1]/[P2]/[P3]/[P4].

- ③ When the “PASSWORD” indication does not clear after inputting 6 digits, the input code number may be incorrect. Turn the power OFF and start over in this case.

■ Channel selection

Several types of channel selections are available. Methods may differ according to your system set up.

NON-ZONE TYPE:

To select the desired operating channel:

- Push [CH Up] or [CH Down].
- Push one of [MR-CH 1] to [MR-CH 4].

ZONE TYPE:

To select the desired zone:

- Push [Zone], then push [CH Up] or [CH Down].

AUTOMATIC SCAN TYPE:

Channel setting is not necessary for this type. When turning power ON, the transceiver automatically starts scanning. Scanning stops when receiving a call.

■ Receiving and transmitting

Receiving:

- ① Push [**Ⓚ**] to turn the power ON.
- ② Push [CH Up] or [CH Down] to select a channel in sequence.
- ③ While receiving a call, adjust the audio output level to a comfortable listening level.

Transmitting:

Wait for the channel to become clear to avoid interference.

- ① Take the microphone off hook.
 - The 'audible' condition is selected and BUSY indicator lights green.
 - A priority channel may be selected automatically.
- ② Wait for the channel to become clear.
 - The channel is busy when BUSY indicator lights green.
- ③ While pushing and holding [PTT], speak into the microphone at your normal voice level.
- ④ Release [PTT] to receive.

- IMPORTANT:** To maximize the readability of your signal;
1. Pause briefly after pushing [PTT].
 2. Hold the microphone 5 to 10 cm (2 to 4 inches) from your mouth, then speak into the microphone at a normal voice level.

◇ Transmitting notes

• Transmit inhibit function

The transceiver has several inhibit functions which restrict transmission under the following conditions:

- The channel is in mute condition ('Inaudible' condition; "◀||)" does not appear.)
 - The channel is busy.
 - Un-matched (or matched) CTCSS is received. (Depending on the pre-setting)
 - Un-matched (or matched) NAC is received.* (Depending on the pre-setting)
 - The selected channel is a 'receive only' channel.
- *Digital mode operation only.

• Time-out timer

After continuous transmission for the pre-programmed time period, the time-out timer is activated, causing the transceiver to stop transmitting.

• Penalty timer

Once the time-out timer is activated, transmission is further inhibited for a period determined by the penalty timer.

2 BASIC OPERATION

■ Clock function

The transceiver indicates the current time and date when [Clock] is pushed. And you can change the indication format and time/date settings.

When you use the transceiver for the first time, or after the transceiver has been left unused for a long time, make sure to check the date and time indication after turning the power ON. If the time and date are not correct, reset them.

◇ Time and date indication

- 1 Push [Clock] to indicate the current time and date on the LCD.
 - When the indication format is set to 12-hour, “AM” or “PM” is indicated.
 - The LCD indication returns to the stand-by mode after 30 sec. has passed with no operation.

The time indication format (12-hour/24-hour)

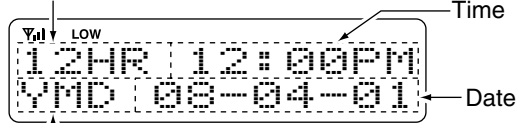

Date indication format (Y: Year, M: Month, D: Day)

- 2 Push [Clock] again to return to the stand-by mode.

◇ Time and date settings

- 1 Push [Clock] to indicate the current time and date on the LCD.

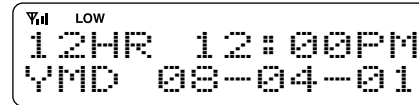

- 2 Push and hold [Clock] for 1 sec. to enter the time and date setting mode.
 - The time indication format, “24HR” or “12HR” blinks.

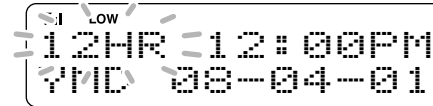

- 3 Push [Clock] to select the desired item to be changed.
- 4 Push [CH Up] or [CH Down] to set the selected item.



- ⑤ Push [Clock] to set.
• The next item blinks.

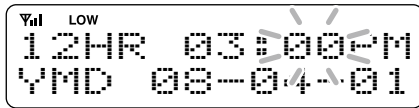

- ⑥ Repeat steps ③ to ⑤ to set items.
⑦ After setting, push and hold [Clock] for 1 sec. to program.
• Return to the time and date setting mode.
⑧ Push [Clock] to return to the stand-by mode.

Wake up function

The wake up function allows the transceiver to be automatically turned ON according to the wake up time setting.

- ① Push and hold [Clock] for 1 sec. to enter the clock set mode.
• “WAKE UP” is indicated.



- ② Push [CH Up] or [CH Down] to turn the wake up function ON.
③ Push [Clock] to set, and select “WAKE UP TIME.”



- ④ Push [CH Up] or [CH Down] to enter the wake up time edit mode.
• The ‘hour’ digit blinks.

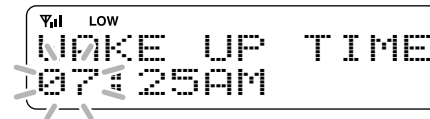

☞ Continues to the next page

2 BASIC OPERATION

- ⑤ Push [CH Up] or [CH Down] to input the 'hour' data for wake up time. After inputting, push [Clock] to set.
- The 'minutes' digit blinks.



- ⑥ Push [CH Up] or [CH Down] to input the 'minutes' data for wake up time. After inputting, push [Clock] to set.



- ⑦ Push and hold [Clock] for 1 sec. to exit the clock set mode.
- Return to the stand-by mode.

■ Sleep function

The sleep function allows the transceiver to be automatically turned OFF according to the sleep time setting.

- ① Push and hold [Clock] for 1 sec. to enter the clock set mode.
- "WAKE UP" is indicated.
- ② Push [Clock] several times to select "SLEEP."

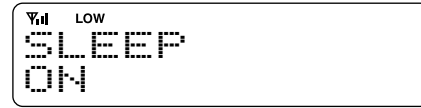

- ③ Push [CH Up] or [CH Down] to select "ON" or "ON EXCPT EMR" to turn the sleep function ON.
- When "ON EXCPT EMER" is selected, the transceiver will be automatically turned OFF at the sleep time. However, during the emergency mode, the sleep function will not function, even if the sleep time period starts.
- ④ Push [Clock] to set, and select "SLEEP TIME."



- ⑤ Push [CH Up] or [CH Down] to enter the sleep time edit mode.

- The 'hour' digit blinks.



- ⑥ Push [CH Up] or [CH Down] to input the 'hour' data for sleep time. After inputting, push [Clock] to set.

- The 'minutes' digit blinks.

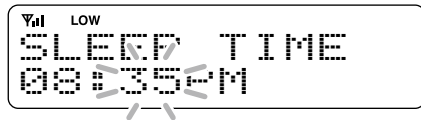

- ⑦ Push [CH Up] or [CH Down] to input the 'minutes' data for sleep time. After inputting, push [Clock] to set.

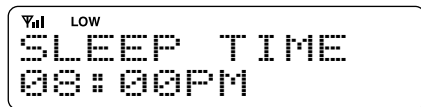

- ⑧ Push and hold [Clock] for 1 sec. to exit the clock set mode.

- Return to the stand-by mode.

■ User set mode

The user set mode is accessed at power ON and allows you to set seldom-changed settings. You can “customize” the transceiver operation to suit your preferences and operating style.

Entering the user set mode:

- ① While pushing and holding [P1] and [P2], push [P0] to turn the power ON.
 - Turn power OFF in advance.
 - You should hold [P1] and [P2] until “SET MODE” appears on the display.

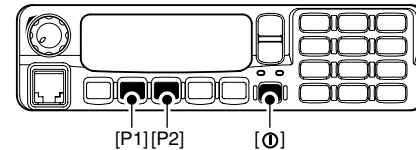

- ② Push and hold [P0] to enter user set mode.

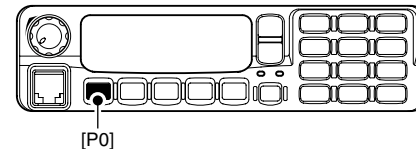

☞ Continues to the next page

2 BASIC OPERATION

- ③ Push [P0] several times to select the appropriate item. Then, push [Up] or [Down] to set the desired level/condition.
- Available set mode functions are **Backlight**, **LCD Contrast**, **Beep**, **Beep Level**, **Ringer Level**, **SQL Level**, **AF Min. Level**, **Mic Gain**, **Horn**, **Battery Voltage**, **Signal Moni**, **Lone Worker** and **System Information**.

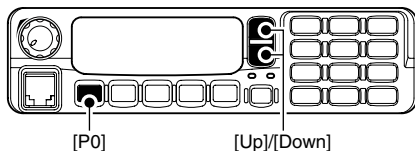

- ④ Push [⓪] again to exit set mode.

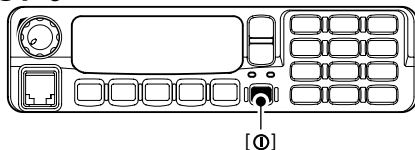

User set mode is also available using a programmable key. Refer to p. 6 [User Set Mode] section.

[User Set Mode] allows for quick item selection. Set “Enable” for the often used items with the CS-F9010/F9510 cloning software. Ask your dealer for details.

NOTE: While in the user set mode, [P0], [Up] and [Down] activate regardless of the assigned functions.

■ Separation cable connection

CAUTION: To avoid damage to the transceiver, disconnect the DC power cable from the transceiver before connecting the separation cable.

/// **NOTE:** The following connections should be performed by your Icom dealer or distributor.

The supplied or optional separation cable is required for the controller and the main unit connection.

See "OPTIONS" on page 22 for the separation cable details.

◇ Controller

- ① Unscrew the 4 screws, then remove the rear plate from the controller.

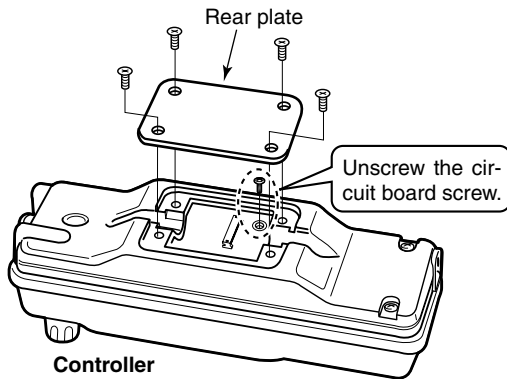

- ② Connect the separation cable to the controller as shown below.

- The cable can be inserted into either the left or right grooves as desired.

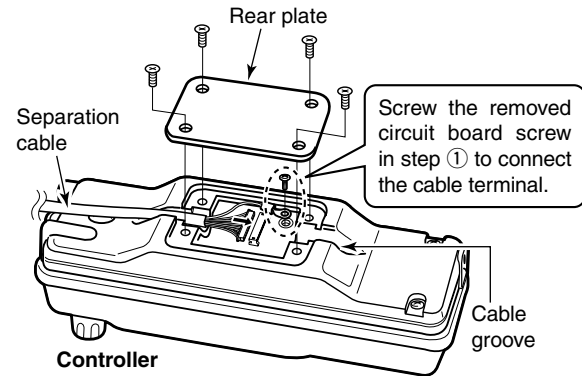

- ③ After the cable connection, replace the removed rear plate and the 4 screws, then connect the opposite side of the separation cable to the main unit. (See the next page)

3 CONNECTION AND MAINTENANCE

◇ Main unit

- ① Unscrew the 4 screws of the front plate (either the left or right), then remove the front plate from the main unit.

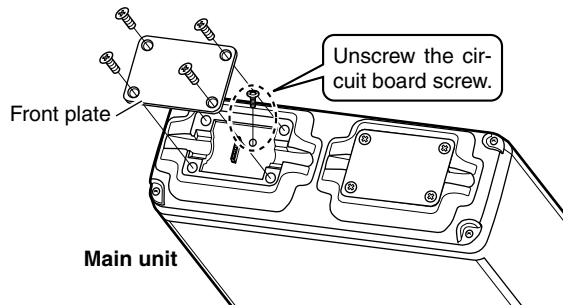

- ② Connect the opposite side of the separation cable that is connected to the controller described on the previous page as shown below.

- The cable can be inserted into either the left or right grooves as desired.

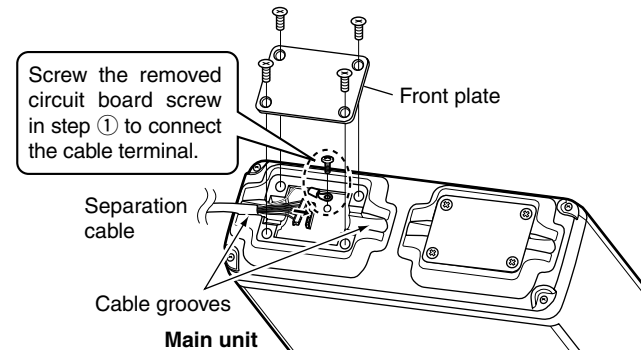

- ③ After the cable connection, replace the removed front plate and the 4 screws, then connect the DC power cable.

■ Rear panel connection

NOTE: The following connections should be performed by your Icom dealer or distributor.

1 D-SUB 25-PIN
Connect an external unit.

2 ANTENNA CONNECTOR
Connects to an antenna.
Contact your dealer about antenna selection and placement.

⚠ WARNING! NEVER remove the fuse-holders from the black and red cables.

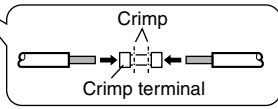
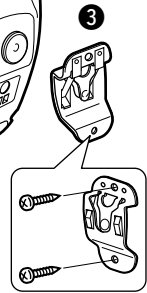
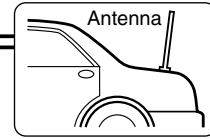
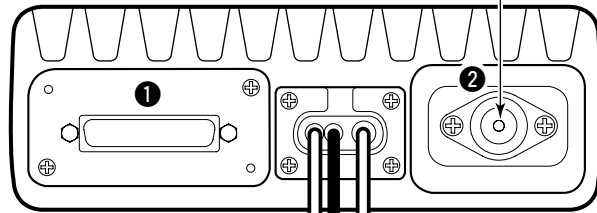
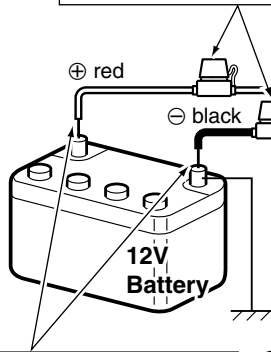

NOTE: Use the terminals as shown below for the cable connections.

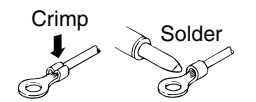

5 DC POWER RECEPTACLE
Connects to a 12 V DC battery. Pay attention to polarities.

⚠ WARNING! NEVER connect to a 24 V battery. This could damage the transceiver.

3 MICROPHONE HANGER
The supplied self ground microphone can be used for microphone on/off hook functions. (See p. 2)

4 EXTERNAL SPEAKER CONNECTOR
Connect a 4–8 Ω external speaker. (See p. 21 for connector information.)

When the optional microphone (HM-152/T) is used:

Purchase separately

Connect the supplied microphone hanger to the vehicle's ground for microphone on/off hook functions when the optional microphone (HM-152/T) is used.

3 CONNECTION AND MAINTENANCE

■ Supplied Accessories

Microphone

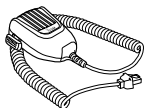

Microphone hanger and screw set



Mounting bracket for main unit

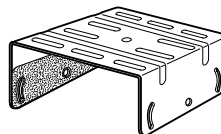

Flat washers (M5)



Mounting screws (M5×12)



DC power cable

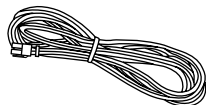

Black and red cables with fuse holders

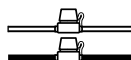

Spring washers (M5)



Self-tapping screws (M5×16)



Socket terminals



Crimp terminals



Fuses*1



Binding bands



Nuts (M5)



Bracket bolts



Separation cable

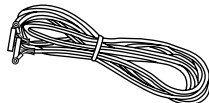

Function name stickers*2

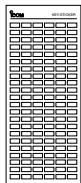

Mounting bracket for controller

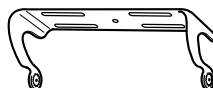

Flat washers (M5)



Mounting screws (M5×12)



Key caps



Housing



Spring washers (M5)



Self-tapping screws (M5×16)



Nuts (M5)



Bracket screws



*1 Fuses should be installed in the fuse holder of the black and red cables, respectively. See p. 20 for details.

*2 Used for labelling the programmable function keys according to their assigned functions.

• **Function name stickers**

There are no names on the programmable function keys since the functions can be freely assigned to these keys. Attach the supplied function name stickers as below to the appropriate keys for easy recognition of the key's assigned function.

Then, protect the attached stickers from unsticking with the supplied key cap as below.

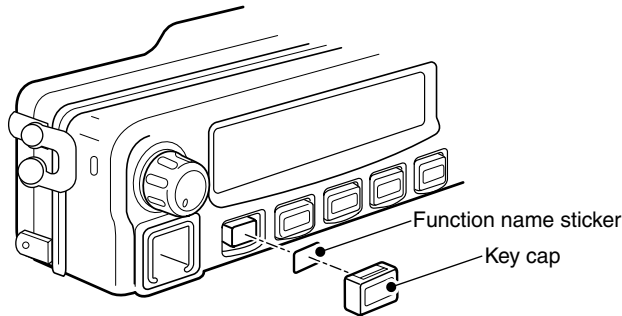

• **Housing**

Insert the speaker cable terminals to the appropriate slots of the supplied housing. See p. 21 for the speaker connector information.

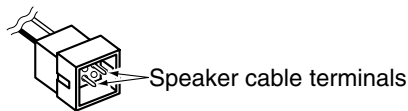

■ Mounting the transceiver

◇ **Main unit**

The universal mounting bracket supplied with your transceiver allows overhead mounting.

- Mount the main unit securely with the 4 supplied screws to a thick surface which can support more than 8 kg (17.63 lb).

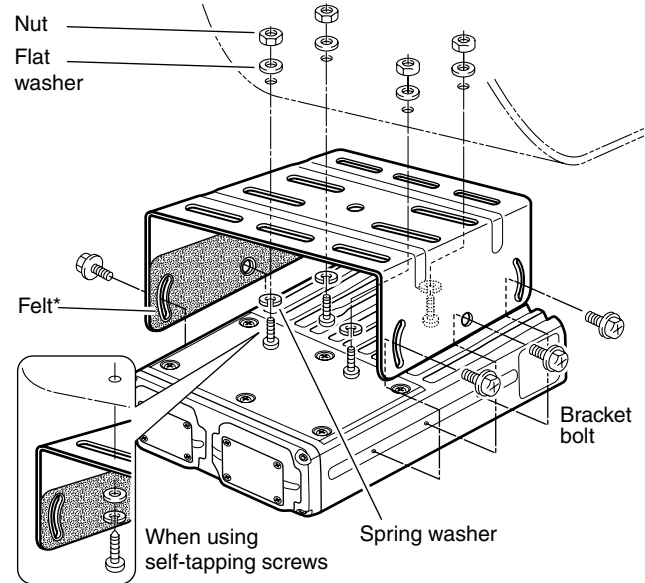

*Felts reduce the vibration effects.

3 CONNECTION AND MAINTENANCE

◇ Controller

2 types of mounting styles are available— one is overhead mounting, and other one is on-board mounting.

On-board mounting

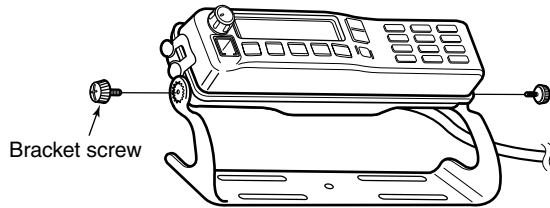

Overhead mounting

- Mount the controller securely with the 4 supplied screws to a thick surface which can support more than 2 kg (4.40 lb). (Overhead mounting)

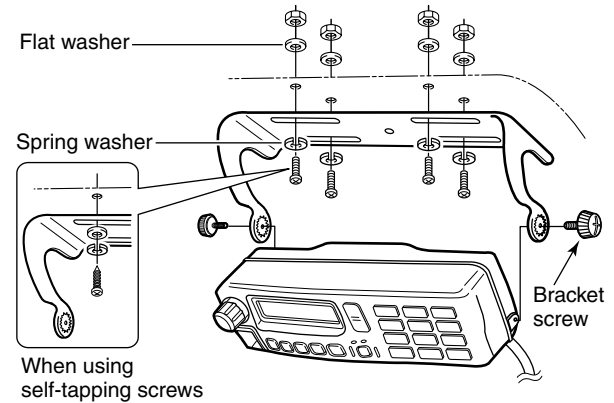

■ Antenna

A key element in the performance of any communication system is an antenna. Contact your dealer about antennas and the best places to mount them.

■ Fuse installation

Fuses should be installed in the fuse holder of the black and red cables, respectively.

If a fuse blows or the transceiver stops functioning, track down the source of the problem, have it repaired, and replace the damaged fuse with a new rated one.

□ Fuse rating: 30 A

USE a 30 A fuse of the same type only.

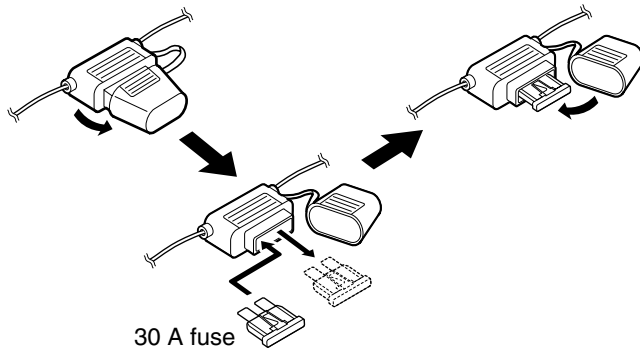

■ Cleaning

If the transceiver becomes dusty or dirty, wipe it clean with a soft, dry cloth.



DO NOT use harsh solvents such as benzine or alcohol, as they may damage the transceiver surfaces.

3 CONNECTION AND MAINTENANCE

■ Speaker connector information

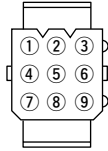

Connector's front view

Pin No.	Name	Description	Specifications
①	IGN	IGSW cont. In	0 – Vcc
②	RXSP1	RX AF Out (BTL)	Output power : Max. 20 W Impedance : 4 Ω
③	NC	—	—
④	HORN1*	Horn drive cont. Out	0 – Vcc Output current: Max. 1 A
⑤	HORN2*	Horn drive cont. Out	0 – Vcc
⑥	RXSP2	RX AF Out (BTL)	Output power : Max. 20 W Impedance : 4 Ω
⑦	PS1	AF Out to PA (BTL)	Output power : Max. 20 W Impedance : 4 Ω
⑧	PS2	AF Out to PA (BTL)	Output power : Max. 20 W Impedance : 4 Ω
⑨	GND	Connects to ground.	—

* When the horn function is activated, HORN1 and HORN2 are shorted.

- **OPC-607/OPC-608/OPC-609/OPC-726**

SEPARATION CABLES

Used for a controller and a main unit connection.

OPC-607 : 3 m; 9.84 ft

OPC-608 : 8 m; 26.3 ft

OPC-609 : 1.9 m; 6.3 ft

OPC-726 : 5 m; 16.4 ft

- **SP-30** EXTERNAL SPEAKER

Input impedance : 4 Ω

Max. input power : 40 W

- **HM-152/HM-152T/HM-148G** HAND MICROPHONES

HM-152 : Hand microphone

HM-152T : DTMF microphone

HM-148G: Self ground heavy duty microphone

- **SM-25** DESKTOP MICROPHONE

- **OPC-1532/OPC-1871** ZONE COPY CABLES

OPC-1532 : Mobile to mobile zone copy cable.

OPC-1871 : Mobile to handy zone copy cable.

- **UT-125** AES/DES ENCRYPTION UNIT

- **UT-128** DES ENCRYPTION UNIT

Approved Icom optional equipment is designed for optimal performance when used with an Icom transceiver.

Icom is not responsible for the destruction or damage to an Icom transceiver in the event it is used with equipment that is not manufactured or approved by Icom.

Some options may not be available in some countries. Please ask your dealer for details.



Your Icom radio generates RF electromagnetic energy during transmit mode. This radio is designed for and classified as “Occupational Use Only”, meaning it must be used only during the course of employment by individuals aware of the hazards, and the ways to minimize such hazards. This radio is **NOT** intended for use by the “General Population” in an uncontrolled environment.

- For compliance with FCC and Industry Canada RF Exposure Requirements, the transmitter antenna installation shall comply with the following two conditions:
 1. The transmitter antenna gain shall not exceed 0 dBi.
 2. IC-F9511HT:

The antenna is required to be located outside of a vehicle and kept at a distance of 66.2 centimeters or more between the transmitting antenna of this device and any persons during operation. For small vehicle as worst case, the antenna shall be located on the roof top at any place on the centre line along the vehicle in order to achieve 66.2 centimeters separation distance. In order to ensure this distance is met, the installation of the antenna must be mounted at least 66.2 centimeters away from the nearest edge of the vehicle in order to protect against exposure to bystanders.
 3. Transmit only when people outside the vehicle are at least the recommended minimum distance of 148 centimeters away from the properly installed antenna. This separation distance will ensure that there is sufficient distance from a properly installed externally-mounted antenna to satisfy the RF exposure requirements in the applicable RF exposure compliance standards.



To ensure that your exposure to RF electromagnetic energy is within the FCC allowable limits for occupational use, always adhere to the following guidelines:

- **DO NOT** operate the radio without a proper antenna attached, as this may damage the radio and may also cause you to exceed FCC RF exposure limits. A proper antenna is the antenna supplied with this radio by the manufacturer or an antenna specifically authorized by the manufacturer for use with this radio.
- **DO NOT** transmit for more than 50% of total radio use time (“50% duty cycle”). Transmitting more than 50% of the time can cause FCC RF exposure compliance requirements to be exceeded. The radio is transmitting when the “TX indicator” lights red. You can cause the radio to transmit by pressing the “PTT” switch.

Electromagnetic Interference/Compatibility

During transmissions, your Icom radio generates RF energy that can possibly cause interference with other devices or systems. To avoid such interference, turn off the radio in areas where signs are posted to do so. **DO NOT** operate the transmitter in areas that are sensitive to electromagnetic radiation such as hospitals, aircraft, and blasting sites.

Count on us!

A-6718D-1US-②
Printed in Japan
© 2008–2010 Icom Inc.

Printed on recycled paper with soy ink.

Icom Inc.

1-1-32 Kamiminami, Hirano-ku, Osaka 547-0003, Japan